

3D Level Scanner

Operating Instructions

3DLS

RL Level Sensor



Contents

1	ABOUT THIS DOCUMENT	4
1.1	SYMBOLS IN USE.....	4
1.2	FOR YOUR SAFETY.....	4
1.3	STORAGE AND TRANSPORT	6
2	3DLEVELSCANNER™ OVERVIEW	7
2.1	THEORY OF OPERATION.....	7
2.2	WIDE APPLICATION RANGE.....	7
2.3	ADVANTAGES	7
2.4	MODELS	8
2.4	VERSIONS	8
3	PHYSICAL INSTALLATION	10
3.1	LOCATION AND POSITIONING GUIDELINES	10
3.2	SCANNER ORIENTATION	12
3.3	SITE PREPARATIONS.....	13
3.4	ASSEMBLY AND MOUNTING.....	14
3.5	WIRING.....	17
4	FIRST-TIME ACTIVATION	21
4.1	LOCAL USER INTERFACE.....	21
4.2	SWITCHING ON THE SCANNER.....	22
4.3	FIRST-TIME ACTIVATION STEPS SUMMARY.....	23
4.4	INITIAL SETUP PROCEDURE	23
5	DIFFERENT CONNECTION METHODS	24
5.1	4-20MA CONNECTION.....	24
5.2	HART COMMUNICATION.....	24
5.3	RS-485 COMMUNICATION.....	25
5.4	COMMUNICATION USING THE 3DLINKPRO	25
5.5	TCP/IP COMMUNICATION.....	25

APPENDIX A: ONBOARD CONFIGURATION	27
OUTPUT SETTINGS.....	27
DISPLAY SETTINGS.....	29
DEVICE INFO.....	30
DEVICE RESET.....	31
APPENDIX B: MAINTENANCE.....	32
APPENDIX C: RECOMMENDED TOOLS	33
APPENDIX D: SPECIFICATIONS.....	34
TECHNICAL DATA	34
DIMENSIONS.....	38
APPENDIX E: STANDARDS & APPROVALS	40

1 About this Document

This operation manual provides detailed product related information, installation, setup and operation instructions for 3DLevelScanner versions S, M and MV. The manual is designed for trained personnel. Please read it entirely and carefully before unpacking and installation of the products.

1.1 Symbols in use

The following symbols indicate different sections of additional information as follows:



IMPORTANT: An indication for additional information, tips, hints, or an indication of helpful additional knowledge.



WARNING: Indication of a potentially dangerous situation, which could result in serious injury to persons and/or damage to the 3DLevelScanner.



EX APPLICATION: An indication of special instructions relevant to installations in hazardous locations.

1.2 For your safety

Authorized personnel

All operations described in this manual must be carried out by authorized, trained personnel only. For safety and warranty reasons, any internal work on the scanners must be carried out by manufacturer-authorized personnel only.

Warning about misuse

Inappropriate or incorrect use of the scanner may result in hazards and application-specific malfunctioning such as vessels overflowing or damage to system components through incorrect mounting or adjustments.

If the 3DLevelScanner is used in a manner not specified in this manual, the protection provided by the 3DLevelScanner will be impaired.

General safety instructions

The 3DLevelScanner is a high-tech device requiring strict observance of standard regulations and guidelines. The user must strictly follow the safety instructions in this operating manual. Local and national electrical codes and all common safety regulations and accident prevention rules must be considered during installation as well.

CE conformity

The 3DLevelScanner conforms to CE's EMC and NSR standards. CE conformity is as follows:

EMC	<ul style="list-style-type: none">▪ EN 61326-1: 2006▪ CISPR 11: 2003 Class A▪ IEC 61000-4-2: 2001 Air Discharge, 8kV▪ IEC 61000-4-3: 2002 80-1000MHz, 1V/m; 1.4-2GHz, 1V.m; 2.0-2.7GHz, 1V/m▪ IEC 61000-4-4: 2004 Power Lines: 1kV; Signal Lines: 0.5kV▪ IEC 61000-4-6: 2004 0.15-80MHz 1VRMS, 80% A.M. by 1kHz Power & Signal Lines
NSR (73/23/EWG)	<ul style="list-style-type: none">▪ EN 61010-1: 2001

FCC conformity (EMC)

FCC Part 15, Sub-part B, Class A.

Safety information for Ex Areas



EX-AREAS: Please note the Ex-specific safety information for installation and operation in Ex areas. These safety instructions are part of the operating instructions manual that comes with Ex-approved scanners.



WARNING: Substitution of components may impair Intrinsic Safety.

WARNING: For preventing ignition of flammable or combustible atmospheres, read, understand and adhere to the manufacturer's live maintenance procedures.

Specific conditions of Use

1. The 3D-Level Scanner is only for use with electronics unit marked with serial number 736XXXXXX or 836XXXXXX as these units are for use with the 3D-Level Scanner ambient temperature range.

-
2. Part of the enclosure is constructed of plastic. To prevent the risk of electrostatic sparking the plastic surface should be cleaned with a damp cloth.
 3. The electronics head must be installed in dust Ex areas where intensive static charging will be avoided.
 4. The device head housing and antenna housing must be installed in gas Ex areas where intensive static charging will be avoided.
 5. Other than for installation or routine maintenance, the front electronics cover must NOT be opened in gas or dust Ex areas. Electrostatic charges must be avoided.
 6. The conditions listed in the respective valid certificates must be strictly observed.
 7. Manufacturer's technical information related to use of the 3D Level Scanner in contact with aggressive/corrosive media and to avoid any risk of mechanical impact shall be observed.
 8. The installation of the device or of the Antenna Unit of models providing head separation in the wall to areas requiring EPL Da equipment shall provide a degree of protection IP66 or IP67 and shall be carried out in such a way, that all metallic parts are integrated in the local equipotential bonding.
 9. Equipotential bonding must be ensured along the intrinsically safe circuit.

1.3 Storage and transport

The scanner is protected by special packaging during transport and is guaranteed to handle normal loads during transport.

2 3DLevelScanner™ Overview

2.1 Theory of Operation

The BinMaster 3DLevelScanner™ is the only device available which delivers accurate measurement of bulk solids and powders – regardless of material type, product characteristics, storage silo type, size, bin or container, and harshness of the storage environment. The product incorporates a unique dust-penetrating technology to achieve an unrivalled degree of process measurement and inventory control.

The 3DLevelScanner™ includes an array of three antennas that generate low frequency acoustic signals and receive echo signals from the contents of the silo, bin, or other container type. Using these antennas, the unit measures not only the time/distance of each echoed signal but also its direction.

The built-in Digital Signal Processor digitally samples and analyses the echoed signals and produces accurate measurements of the level, volume, and mass of the stored contents, and generates a 3D representation of the position and form of the material within the container for displaying on remote computer screens.

2.2 Wide Application Range

The 3DLevelScanner™ measures virtually any kind of solid material, stored in a variety of containers, including large open bins, bulk solid storage rooms, stockpiles and warehouses, mapping loads that randomly form over time inside silos, and many other challenging applications that were not possible until now. The sensor can measure ranges of up to 70m (200ft) and generate 3D mapping of the material surface.

2.3 Advantages

- Service and maintenance-friendly - Non-contact measuring principles, the 3DLevelScanner™ is easy to service and maintain
- Ideal for solid volume measurement applications
- The only available device that measures minimum and maximum levels
- Suitable for measuring all solid materials (including ones with low dielectric constants)
- Operates in dusty and moisture environments
- Profiles of buildup of materials to vessel walls
- Self-cleaning antenna

-
- 3-Dimensional mapping visualization tool for filling-point choosing assistance (in vessels with multiple filling points)
 - The most reliable sensor available - includes 3 transmitters and 3 receivers

2.4 Models

The 3DLevelScanner™ line of products consists of the following models:

- 3DLS and II DX B GD V M T0
- 3DLS -TC and II DX C GD V M T0
- RL Level Sensor, RL-TC Level Sensor and RL2000 II DX B GD V M X

3DLS 3D-Level Scanner II DX B GD V M T0

3DLS-TC Level Scanner II DX C GD V M T0

The 3DLS and II DX B GD V M T0 scanners provide continuous, non-contact level measurement using dust-penetrating technology for unsurpassed bin volume accuracy. Unlike single point devices, BinMaster's 3DLevelScanners measure multiple points to detect irregular material surfaces, cone up/down conditions, or sidewall buildup. Advanced acoustics-based technology is proven to perform in powders and bulk solids contained in tanks, silos, domes, warehouses, open bins, and piles.

The 3DLS-TC and II DX C GD V M T0 is supplied with a Teflon coated horn antenna to resist dust buildup in powdered materials that cling to the sensor and cause performance or maintenance issues.

RL Level Sensor RL2000 II DX B GD V M X

RL-TC Level Sensor

The RL Level Sensor and RL2000 II DX B GD V M X is highly reliable even in extreme dust, the BinMaster RL level sensor is a non-contact level sensor that works in powders and solid materials of all types--including very low dielectric materials. The BinMaster RL measures a single point in the bin using acoustics-based technology to provide continuous level measurement in a self-cleaning, low maintenance sensor

The RL-TC is supplied with a Teflon coated horn antenna to resist dust buildup in powdered materials that cling to the sensor and cause performance or maintenance issues.

2.5 Versions

The 3DLevelScanner™ line of products consists of three version: **S**, **M** and **MV** defined by firmware.

Version S

The S version determines the average level of the stored contents and average distance from the scanner to the surface of the material. Based on a 30° beam angle, the S model is ideal for small and narrow vessels of up to 4m (13 ft) in diameter.

Version M

The M version yields highly accurate readings of level and volume. It is appropriate for large vessels of up to 15m (50ft) in diameter and at least twice as high (30m / 100ft), open bins and stockpiles. It is based on a 70° beam angle. The M model also presents the minimum and maximum Level/Distance measurements along with the calculated average.

Version MV

The MV version is identical to the M model, with the additional capability of generating a 3-dimensional representation of the stored contents on a remote computer. This feature is highly useful for mapping buildup loads that form randomly over time and other irregularities.

All three version are available in various modes, such as ATEX approved, FM approved, and non-ATEX (for more information, see matrix below and **Approvals** on page 37) and also available with neck extension (see *Appendix B: Accessories: Neck* on page 30).

Each of the models is available in two temperature ranges:

3DLevelScanner II is compatible in applications where the maximal temperature in the surroundings inside the vessel is up to 85°C (185°F).

3DLevelScanner II HT is compatible in applications where the maximal temperature in the surroundings inside the vessel is up to 120°C (248°F).

Note: The model 3DLevelScanner II high temperature version is NOT FM / IECEx / ATEX approved and only the standard temperature model rated for -40C to +85C has FM / IECEx / ATEX approvals.

All references in this manual to the 3DLevelScanner can be referred to as 3DLevelScanner or simply the scanner, if nothing else is mentioned it applies to any of the scanner's models.

Certification Matrix

	Model	FM	IECEx	ATEX
Standard Temperature	3DLS	Yes	Yes	Yes
	3D Level Scanner II DX B GD V M T0	Yes	No	No
Teflon Antenna	3DLS -TC	Yes	No	No
	3D Level Scanner II DX C GD V M T0	Yes	No	No
RL	RL Level Sensor	Yes	Yes	Yes
	RL2000 II DX B GD V M X	Yes	No	No
	RL-TC Level Sensor	Yes	No	No
High Temperature (HT)	HT-180	No	No	No

3 Physical Installation

This chapter describes the necessary steps for proper installation of the 3DLevelScanner beginning with important pre-installation considerations such as environmental conditions, correct positioning and orientation, through the mounting and configuration process.

3.1 Location and positioning guidelines

Choosing the proper location to the 3DLevelScanner™ should consider every aspect of the vessel and contained materials, including the silo or vessel dimensions, type of material and angle of repose, locations of filling and emptying points, maximum level of material, internal construction and moving part and any other consideration which may possibly affect the scanner performance. BinMaster strongly recommends installing the 3DLevelScanner according to the 3DScanner Locator PC software for properly choosing installation location and positioning. In case of no satisfying software solution, please contact BinMaster Customer Support for assistance with the positioning.

Moisture and water condensation



Use the recommended cable gland and tighten the cable connection. For additional protection against moisture, lead the connection cable downward in front of the cable entry. Rain and condensation water can thus drain off. This applies mainly to mounting in areas where moisture is expected (e.g., by cleaning processes), or on cooled or heated vessels.

Measuring range

The measuring range is set in the scanner and defined by silo dimensions and the full and empty calibration levels. These levels set the 100% and 0% values relatively.

The scanner measurements are calibrated to the top of the body. If the scanner is lowered or mounted with neck extension or head-body separation, it is important to adjust all measurements to the top of the body.



NOTE: If the material level reaches the antenna, buildup could form inside the horn over time and cause measurement errors or damage to the membranes.

NOTE: the 3DLevelScanner™ has a 500mm (16 ") of dead zone (or blanking zone).

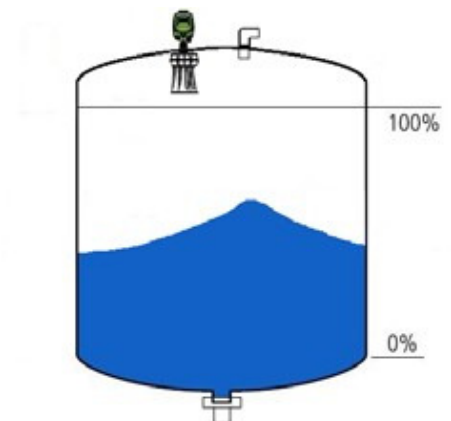

Pressure

The process fitting must be sealed in the case of a low pressured vessel. Before usage, verify that the sealing material is resistant to the stored medium. The maximum allowed pressure (stated in *page 35: Appendix E: Specifications*) is indicated on the label of the sensor.

Installation location

Choosing the proper installation location for the 3DLevelScanner is an important part of the installation process. A wrong location may result in erroneous measurements or loss of performance.

The usage of the 3DScanner Locator Software is recommended for finding the optimal location, which is based on various parameters.

The following factors must be taken into consideration while choosing the installation position: vessel dimensions, filling and emptying point locations, internal structure or support and other restrictions related to vicinity to noisy devices (such as electrical motor) and any other element which may affect the proper operation of the scanner.



IMPORTANT: When mounting the 3DLevelScanner, do not install the scanner near the vessel wall. The installation must consider the vessel dimensions. Installing the scanner near the side wall will result in bad performance.

Installing the 3DLevelscanner at the center of the vessel is not recommended, since the perfect symmetry from all sides toward the scanner may affect the echoes distinction.

- The scanner cannot be mounted at a distance lower than 500mm (16") from the wall.
- When choosing the installation location, consider the filling and emptying points.
- Use the 3D Scanner Locator PC software for choosing a proper location.

3.2 Scanner Orientation

Mounting direction

Mounting of the 3DLevelScanner at a specific direction is important. The ridge on the horn body, and the notch on the top of the thread (representing antenna no.1) should be directed toward the center of the vessel.

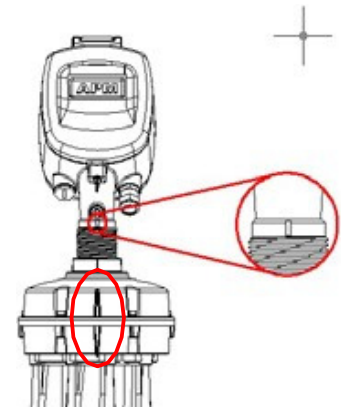
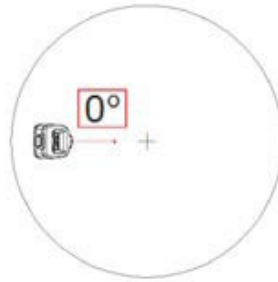
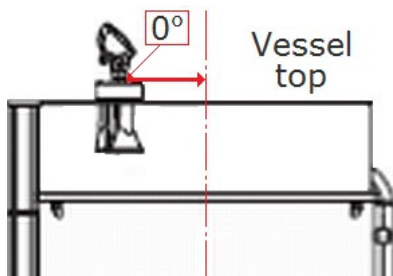

The 0° label location

Mounting direction. 0° indication toward vessel center

Standpipe mounting

When mounting the scanner using a standpipe part it should be assembled and positioned at a height that leaves at least 10mm (0.4") out of the standpipe, for the antenna end protrudes, as shown in the figure to the right.

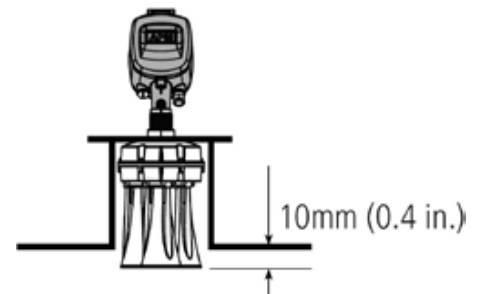

IMPORTANT: Any obstruction as well as rails, frames or support beams should never interfere with the acoustic beam transmitted and received, as shown in the figure to the right.

This comment applies to all 3DLevelScanner models including the S model.



Wrong

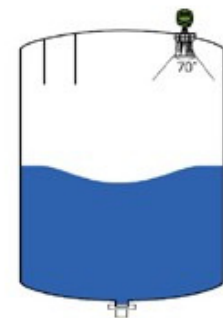

Correct

Inflowing material

Do not mount the scanners in or above the filling stream, not too far from the stream, and not in the direction of the filling stream in case it is diagonal, to avoid damage to the scanner from the flowing material. The scanner should be located with a clear line of sight to the top of the material at high levels, not to be affected by the filling stream or the noise it creates.



Fitting

The fitting area should be prepared to maintain the horns/antennas vertically positioned to the ground, as shown in the figure.

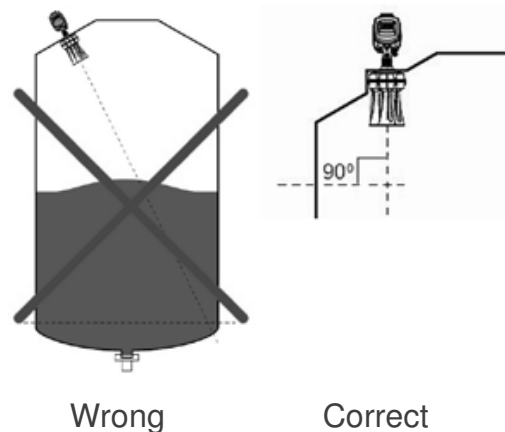

3.3 Site Preparations



IMPORTANT: The site preparations described in this section must be complete and verified prior to installation. For optimal installation, ensure that the 3DLevelScanner can be positioned and fitted according to the guidelines described in the beginning of this chapter.

For a list of items recommended to prepare before installing the 3DLevelScanner, refer to *page 34: Appendix D: Recommended Tools*.

Before installing, make sure the following preparations have been completed.

Power

- Connecting the 3DLevelScanner chassis to the facility grounding is important for protection.
- A 24VDC (1.5 Watt) power supply must be prepared and ready to use near the scanner mounting location.
- The 3DLevelScanner is a 4-Wire device. The voltage supply and data output (4-20mA) are carried along two separated two-wire connection cables.

Communications

- Route communication cables in proper conduits and use a proper cable type.
- The cable used for RS-485 should be of twisted-pair type, shielded, with 120 Ohm impedance and approved for RS-485 communications.
- The cable used for 4-20mA should be rated for analog signals, twisted-pair, low resistance and shielded.

3.4 Assembly and Mounting

Package Contents

The supplied package includes:

- 3DLevelScanner sensor
- Documentation
- CD with the 3DLevel Manager software and marketing materials
- Cable glands accessory kit
- Ex-specific safety instructions (with Ex versions)
- Certificates if applicable

Included components

The 3DLevelScanner includes the following components:



3DLevelScanner Body



3DLevelScanner Head

- 3DLevelScanner Body: Includes three antennas, transducers and temperature sensor. The flange is mounted on the body and tightened to it.
- 3DLevelScanner Head: Includes the electronic board and all wiring connections. The Head is mounted on the body.



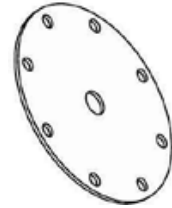

Flange preparation

Prior to the installation of the 3DLevelScanner, an installation flange should be prepared. The flange must have a 52mm (2.05") hole for the scanner body thread insertion.

BinMaster provides two types of standard flanges. Please refer to *page 28: Appendix B: Accessories* for flange specifications.

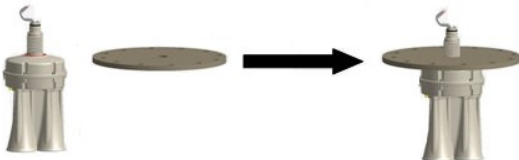

Installing the Flange

<p>1 Verify the O-Ring on the neck tube remains in place as shown:</p> 	<p>2 Use 18 " adjustable pliers or 24 " wrench to untighten and remove the nut from the neck tube.</p> 
<p>3 Place flange over the neck tube, insert until placed as shown:</p> 	<p>4 Replace the nut and tighten it over the neck tube to the flange, using an 18 " adjustable wrench. Make sure the scanner is well tightened to the flange to prevent vibration and for proper sealing. When mounting the scanner body and flange to the silo standpipe make sure the scanner is facing the center of the silo as described in <i>Scanner Orientation on page 9.</i></p> 

Installing the Scanner Head

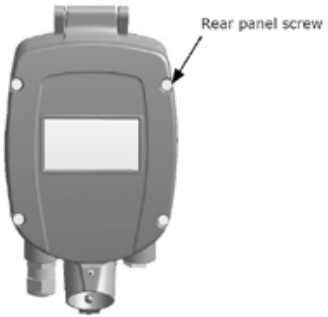
<p>1 Unpack the scanner head. Untighten the four screws of the housing rear panel using a 4mm hex key and remove the rear panel. The screws are of captive type and will not fall off.</p>	
--	---

- ② Remove the cable clamp located at the bottom inside the scanner as shown.

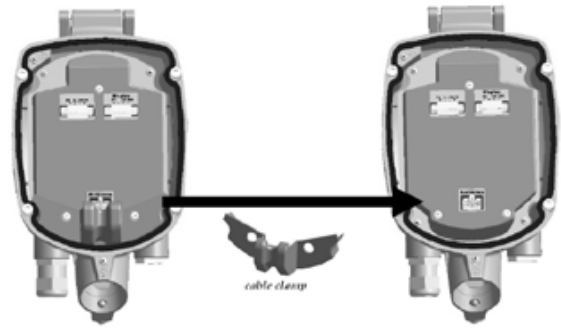

- ③ **Gently** insert the antenna cable through the scanner head. Make sure not to damage the (white) cable connector. This connector connects the transmission signal from the electronic board to the transducers. Damage to the connector or to the wires will result with malfunctioning operation of the scanner.

- ④ Insert the scanner head onto the neck tube.



IMPORTANT: When inserting the scanner head onto the neck tube, make sure to push the head all the way down until it fully contacts the top of the neck tube.

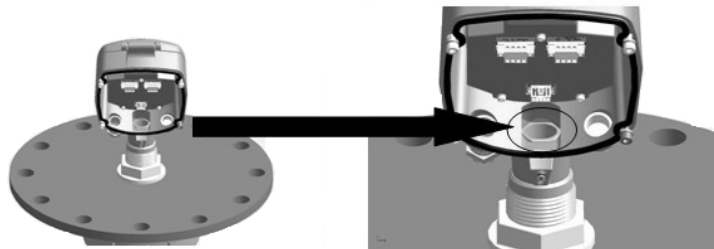

NOTE: It is recommended to lubricate the O-Ring on the neck tube prior to installing the scanner head. This makes it easier to insert and properly locate the scanner head over the tube neck.

NOTE: The 3DLevelScanner head may be installed in six different positions.

- ⑤ Tighten the front screw using a 4mm hex key and a 13mm wrench. Torque to 35 in lb (4.0 NM).



- ⑥ Replace the cable clamp back to position, between the antenna cable and the electronic board.

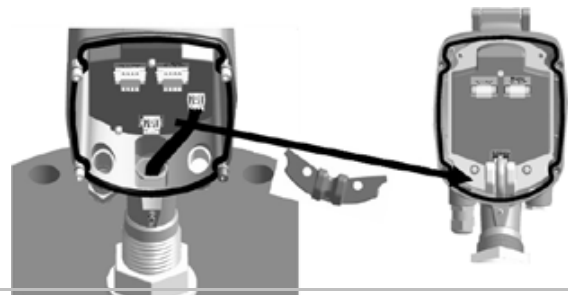

- 7 **Carefully** connect the antenna cable connector back to the electronic board as shown.

This connector allows the transmission signal from the electronic board to the transducers. Damaged connector or wires will result with malfunctioning operation of the scanner.

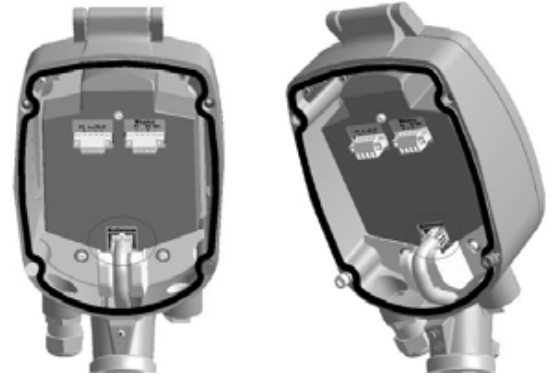

- 8 Leave the scanner open at this stage to complete the wiring.

3.5 Wiring

The 3DLevelScanner can be connected in different modes and configurations for different external systems such as PLC or DCS and communications on RS-485, ModBus, HART and also to RS-485 bus converting adapters to communication gateways such as 3DLinkPro for GMS or GPRS data relay and TCP/IP gateway. For in-depth details and explanations on wiring and communication, refer to *page 21: Different Connection Methods*.

- Use 8-13mm (20 AWG) diameter cables to ensure proper and effective sealing of the cable gland entry opening.
- Select a cable suitable for application (indoor or outdoor) and safety certified according to national regulations.

Communications



NOTE: If electromagnetic interference is expected, usage of a screened and twisted wired cable is recommended for the signal lines, which should be connected to the ground reference.



CAUTION: Always observe the following safety instructions:

Connections must be made only in the complete absence of line voltage.

If over-voltage is expected, overvoltage arresters should be installed.

Use only a safety-certified power supply with dual insulation between the primary and output for powering the unit. The power supply output rating must be limited to 26.6 VDC, 1A for a single 3DLevelScanner device, and not to be connected to a DC distribution network.



In hazardous areas you should take note of the appropriate regulations, conformity and type of approval certificates of the sensors and power supply units. Refer to the printed safety manual provided with the ATEX/FM approved 3DLevelScanner.

Power Supply

For power supply specifications, refer to *page 36: Appendix E: Specifications* for full details.

4-20 mA/HART 4-wire: The power supply and signal current inputs must be carried over two separated pairs.

Connection Procedure

- ① Untighten the four screws of the scanner housing rear panel and remove the rear panel. The screws are of captive type and will not fall off.

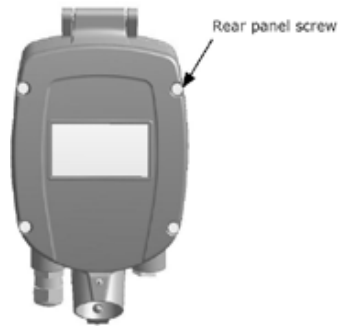

- ② Loosen the compression nut of the cable gland entry.

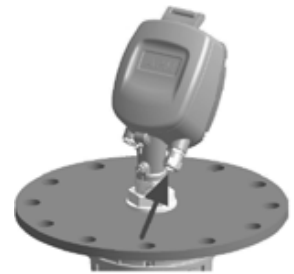

- ③ Insert the cable into the scanner through the cable gland and entry opening.

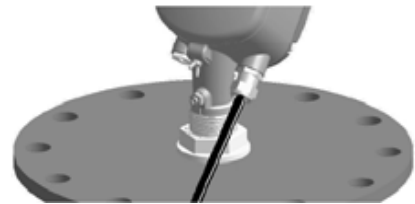

- ④ Remove approximately 10cm (4 ") of the cable mantle and strip approximately 1cm (0.4 ") the edge of each conductor.

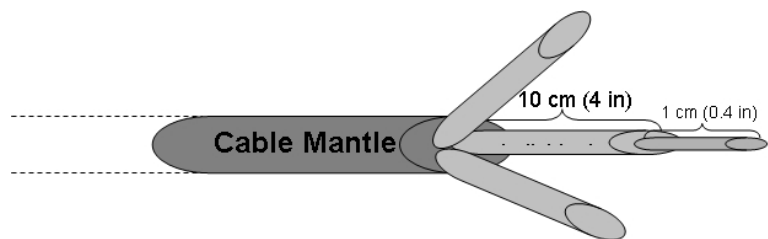

- ⑤ Open the terminal block screws located inside the scanner housing using a thin flat (A3/32") screwdriver. Insert the wire edges into the terminals according to the wiring plan detailed next and fasten the terminal screws. Gently pull the wires to ensure they are securely connected.

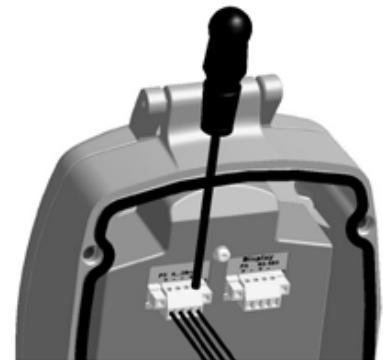

6 Terminal block wiring plan.

The tables below describe the connections.

Refer to the following Local Connection and Multi-Drop Connection drawings for details.

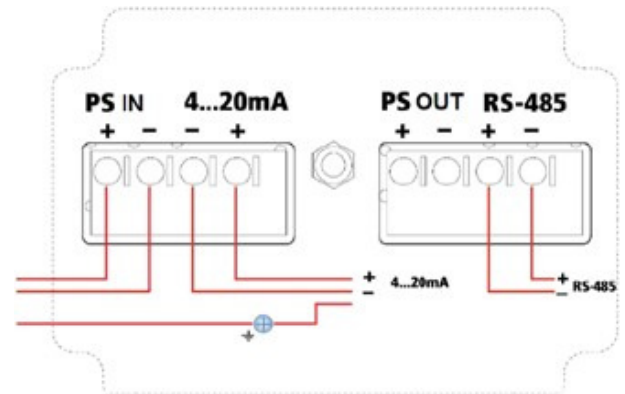

Left Connector	
Ports	Description
PS IN + -	Feed in power supply 20-26.6 VDC, 1A
4..20mA + -	4 - 20 / HART Communications terminals

Right Connector	
Ports	Description
PS OUT + -	No to be used!
RS-485 + -	RS-485 / Modbus RTU Communications terminals

7 Connect the external ground terminal with potential equalization to the external ground terminal of the scanner, located as shown.

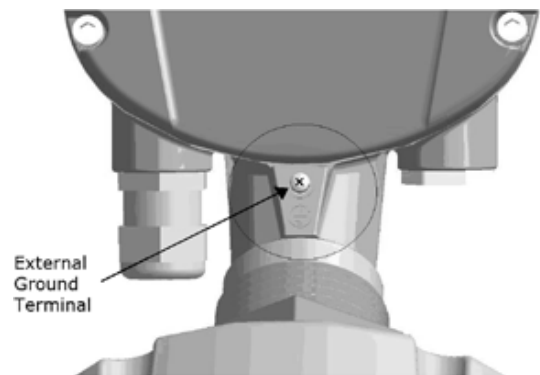

An internal ground connection is also possible using the inner connection as shown.

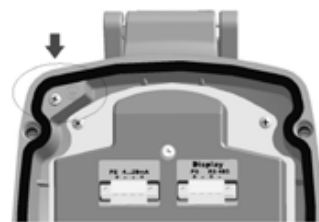

8 Tighten the compression nut over the cable gland entry opening. Verify that the sealing ring completely wraps the cable.



IMPORTANT: Gland compression nut tightening provides good sealing. It is necessary for the scanner to maintain IP67 requirements, and for extended scanner lifetime.

- 9 Attach the rear panel back to position at the rear of the scanner housing and tighten the four screws to secure it in place, using a 4mm hex key. Torque to 15 in lb (1.7NM).
The 3DLevelScanner is ready for configuration.



IMPORTANT: Use direct connection between the scanners and the plant (PLC/SCADA).

IMPORTANT: For a remote connection, use the 3DLinkPro remote connection module or a local PC/Laptop computer as detailed in the following drawing.



CAUTION: Do not connect the power supply cables to the 4-20mA/HART input, to the RS-485 ports or to the PS output.

The 3DLevelScanner is not a loop powered device but a 4W device.

The **PS** ports in the right connector are Power Supply **OUT**. Do not plug **IN** power supply in these ports.



WARNING: The 4-20mA / HART lines should NOT be connected using multidrop.

4 First-Time Activation

4.1 Local User Interface

Configuration and adjustment of the 3DLevelScanner must be done using the 3DLevelManager software, with the optional addition of GSM/GPRS communications using 3DLinkPro. For detailed configuration procedure, refer to *the BinMaster 3DLevelManager Software Manual* and the *3DLinkPro Manual*.

The 3DLevelScanner User Interface

The user interface includes a 4-line LCD display and the four keys located on the front side of the device, marked ESC, +, - and E.

Key functions are as follows:

- ESC** Navigates back within a function menu.
Continuous 3 second press exits to the default screen.
- +** Navigates upwards in the navigation list.
Navigates right within a function.
- Navigates downwards in the navigation list.
Navigates left within a function.
- E** Navigates to the right when within a function group.
Stores a value once configured.



The following, simultaneous key-press combinations perform special functions as follows:

- + E** Increase/decrease the LCD display intensity.
- E** Press and hold the **E** button, then use the **+** or **-** buttons to increase or decrease the intensity of the display.

Operating menu

The operating menu consists of two levels:

- **Function groups:** The scanner functions are organized groups. Available function groups are: Basic setup, Linearization, Extended Calibration, Output Settings, Display Settings, Device Info and Device Reset.
- **Functions:** Each function group consists of one or more functions. The functions may perform different actions or modify scanner setting parameters. Numerical values can be entered, and parameters can be selected and saved.

4.2 Switching on the scanner

Once the 3DLevelScanner is connected to the power supply and switched on, it initializes a self-test which lasts for approximately 30 seconds. When the initialization is complete, the following content is displayed allowing selecting a language and distance units:

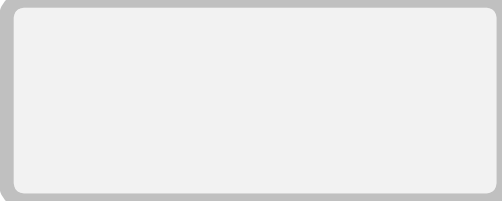
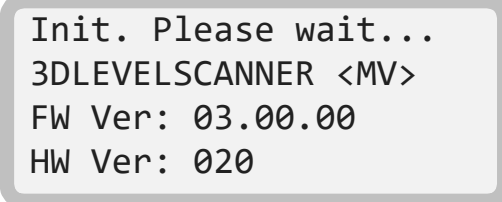
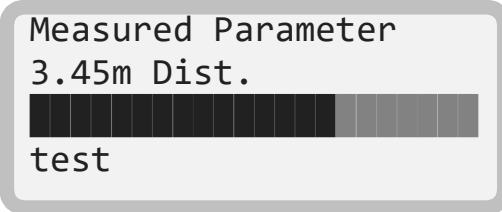
<p>1 The unit is turned on and is initializing for about 30 seconds, during which the display remains blank.</p>	
<p>2 The version screen appears: The value in <> describes the scanner model: S, M, MV or MVL. FW Ver: firmware version HW Ver: hardware version</p>	
<p>3 Once the startup process is complete, the following screen appears showing the current distance measurement. The fourth line displays the scanner tag name. By default, when the name has not been configured yet, this line remains empty. Press E to return to the Main Menu. Press ESC for 3 seconds to switch to the basic measurement screen.</p>	

4.3 First-time Activation Steps Summary

Here is a list of all the actions taken during the first-time activation of the scanner:

- 1 Connect power to the scanner. After about 30 seconds duration, the version screen appears.
- 2 After a little while, the display switches to the current distance measurement screen.
- 3 Press **E** to enter the Main Menu.
- 4 In the Main Menu, choose Output Settings, by pressing **E**, and set the polling address.

Following completion of the first-time activation tasks, use the 3DLevelManager software to establish the connection and to make all the necessary configurations.

4.4 Initial Setup procedure

Setting the scanner address

The sensor address setting is mandatory when multiple sensors are connected over a RS-485 Multi-drop (Daisy Chain). Addresses must be set prior to parameter adjustment.

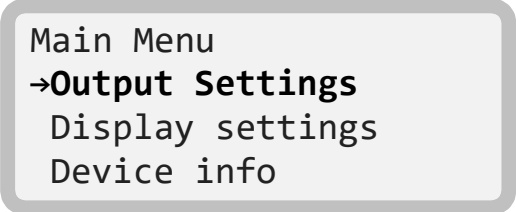
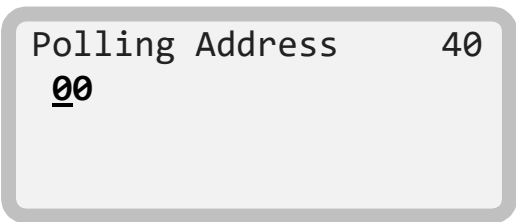
<p>1 At the Main Menu, scroll down to Output Settings option using the ↓ key and press E to switch to the Polling Address configuration screen.</p>	 <p>Main Menu →Output Settings Display settings Device info</p>
<p>2 Use the ← key to switch between the two digits. Use the + key to modify the value. The default polling address is 00. The polling address range from 00 to 63. Press E to store the modified address.</p>	 <p>Polling Address 40 <u>00</u></p>

5 Different Connection Methods

Using the 3DLevelManager for communicating with the 3DLevelScanner allows the user to choose several communication types: RS-485, HART, GSM, GPRS and TCP/IP, for more information and details regarding the communications, refer to *the BinMaster 3DLevelManger Software Instructions manual*.

5.1 4-20mA Connection

The 3DLevelScanner outputs the % of Volume as set in the configuration and between the Full and Empty calibration levels. The 4-20mA current output is available through ports 3 and 4 of the left green connector (as shown in the drawing to the right). Ports 3 and 4 are the negative and positive poles, respectively.

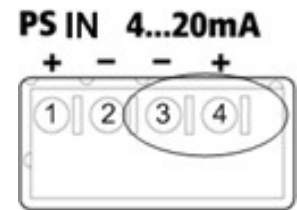

The 4-20mA line is connected directly from the scanner mounted on the vessel to the PLC/DCS/Display or any other device (as shown below).



IMPORTANT: This type of connection is active and not passive, hence the 3DLevelScanner is the active module and the PLC should be the passive module.

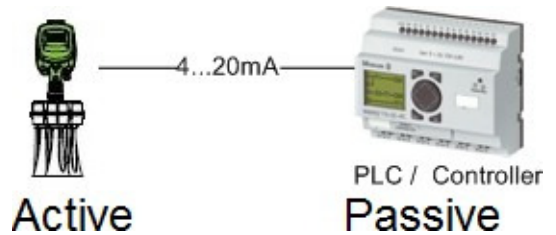

5.2 HART Communication

The 3DLevelScanner supports HART protocol over the 4-20mA wires. By connecting a 250 Ohm resistor on one of the wires and a HART modem and communication to and from the scanner can be established from the 3DLevelManager software.

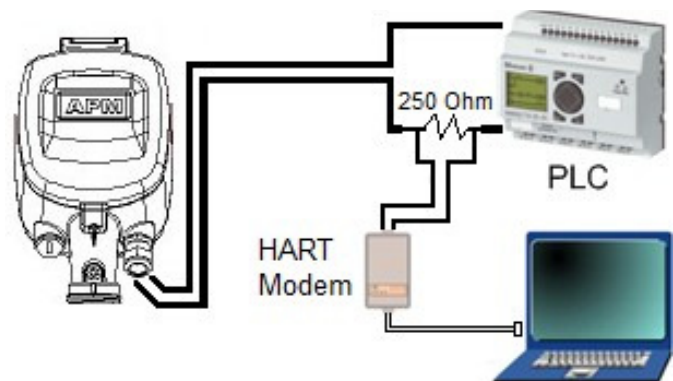

5.3 RS-485 Communication

The 3DLevelScanner includes an RS-485 communication port. This type of connection allows a computer to communicate with the scanner. It also allows a multiple scanner connection on the same RS-485 bus and communication with all scanners using a single connection to the computer running the software.

In both single or multi scanner connection, it is required to use an appropriate cable rated for RS-485, the cable should be of twisted pair, has 120 Ohm impedance and shielded. The total length of the cable should not reach 1000m (3280ft).

In case of a multi scanner connection, all scanners must be connected in parallel mode in the RS-485 ports. Hence, all the '+' (positive) ports of the RS-485 should commonly be connected and all the '-' (negative) ports of the RS-485 should be connected commonly. The connection must be of Daisy-Chain type and have at each of the far ends of the chain 120 Ohm resistor (such resistor is provided with the scanner).

Each Scanner must be configured with a different polling address.

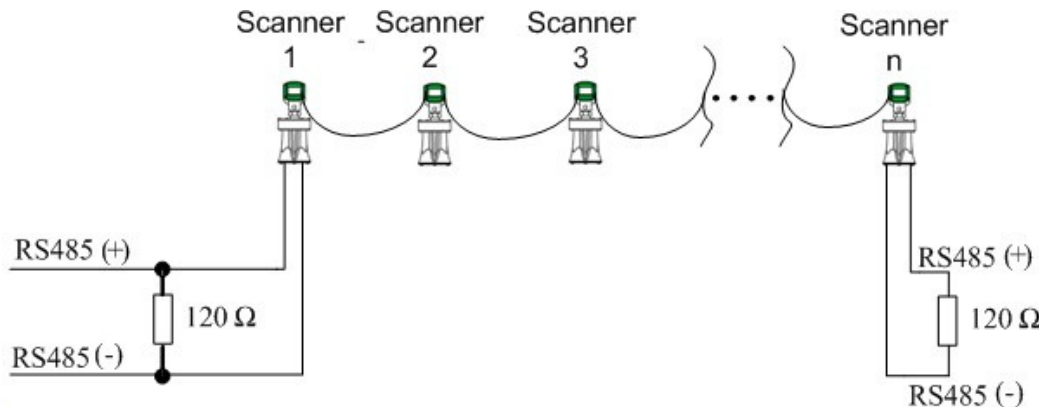

5.4 Communication using the 3DLinkPro

In both single and multiple scanner installation, the 3DLevelScanner can be connected to a GSM/GPRS modem in order to transfer the data over the cellular network. The 3DLinkPro should be connected on the RS-485 bus as any of the scanners, including cable and resistors as needed. For further details on wiring and connections, refer to the *BinMaster 3DLinkPro manual* and to the *3DLevelManager Software Instructions manual*.



NOTE: In such communication mode, only one computer running the 3DLevelManager software can be connected to the scanners.

5.5 TCP/IP Communication



The RS-485 bus can be converted to TCP/IP communication. TCP/IP to RS4585 converter installation should be done as with any scanner, including the resistors and daisy-chain considerations.





NOTE: Consult with BinMaster Technical Support team for assistance on the proper TCP/IP converter to use.



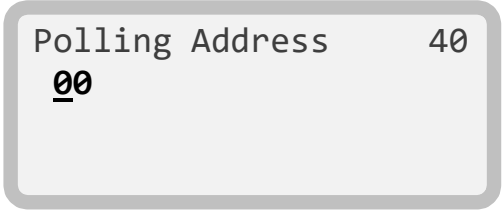

Appendix A: Onboard Configuration

Output Settings

This function defines the scanner Polling Address, and further to Measured Parameter settings. Navigate down the Main Menu screen using the  key, select the **Output Settings** option and press  to enter the Output settings menu.

<p>The first screen of Output Settings allows setting the scanner polling address.</p> <p>Select the proper Polling Address using the  /  keys and press  to proceed.</p> <p>Exiting this menu automatically switches to the Measured Params. menu.</p>	
---	--

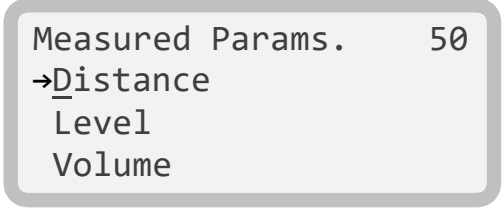
The following functions set displayed measurement units for Distance, Level, Volume, Temperature, and their maximum allowed values. As well, it allows reading the current measurements for Analog Output, SNR and Temperature. This menu is not accessible from the main menu. It will appear following completion of the Output Settings or the Display Settings menus.

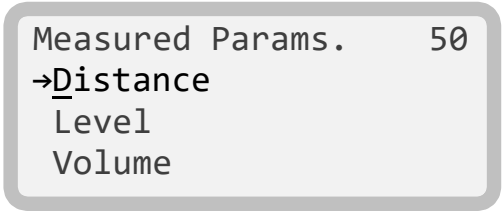
<p>Navigate up/down the menu using the  /  keys, and Press  to select the desired option.</p>	
<p>1 Measurement Distance settings</p> <p>Select the Distance option and press  to proceed.</p>	

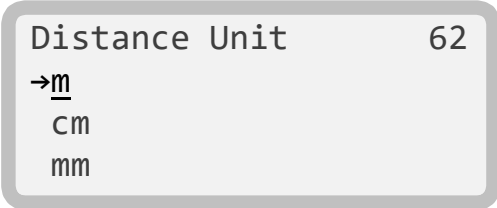
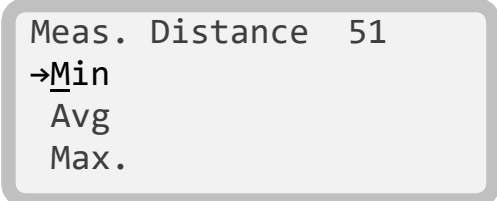
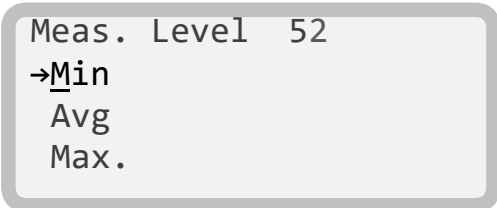
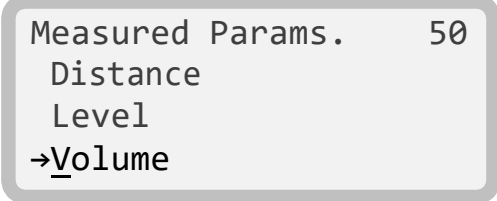
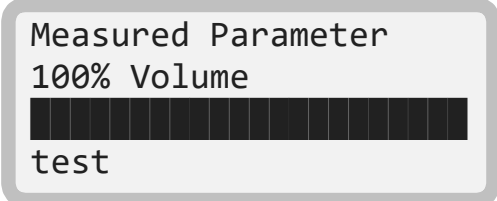
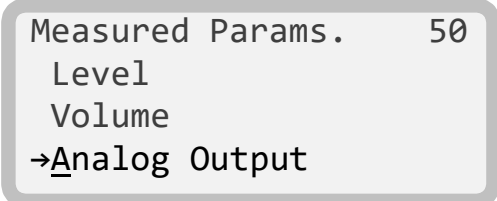
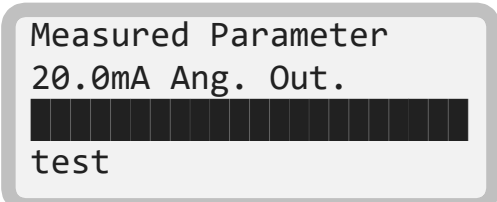
<p>② Select the desired Distance Unit using the \oplus / \ominus keys and press E to store the option and proceed.</p>	
<p>③ This menu defines how the Measured Distance is displayed: by a minimum value, a maximum value, or an average value. Select the desired option using the \oplus / \ominus keys. Press E to store and proceed.</p>	
<p>④ Measurement Level settings This menu defines how the Measured Level is displayed: by a minimum value, a maximum value, or an average value. Select the desired Meas. Level option using the \oplus / \ominus keys. Press E to store and proceed.</p>	
<p>Measurement Volume Select the Volume option from the Measured Params. Menu. Press E to proceed.</p> <p>The Measured Parameter screen is shown, displaying the Volume percentage.</p>	 
<p>Analog Output Select the Analog Output option from the Measured Params. Menu. Press E to proceed.</p> <p>The Measured Parameter screen is shown, displaying the Analog Output value in mA.</p>	 

<p>SNR</p> <p>Select the SNR option from the Measured Params. Menu. Press E to proceed.</p> <p>The Measured Parameter screen is shown, displaying the SNR value in dB.</p>	<div data-bbox="943 239 1458 453"> <p>Measured Params. 50 Volume Analog Output →<u>S</u>NR</p> </div> <div data-bbox="943 478 1458 693"> <p>Measured Parameter 8.0dB SNR ████████████████████ test</p> </div>
<p>Temperature</p> <p>Select the Temperature option from the Measured Params. Menu. Press E to proceed.</p> <p>Select the desired temperature measurement units using the + / - keys and press E to store and proceed.</p> <p>The Measured Parameter screen is shown, displaying the measured temperature value using the selected units.</p>	<div data-bbox="943 737 1458 951"> <p>Measured Params. 50 Analog Output SNR →<u>T</u>emperature</p> </div> <div data-bbox="943 997 1458 1211"> <p>Temperature Unit 64 →<u>°C</u> °F</p> </div> <div data-bbox="943 1257 1458 1472"> <p>Measured Parameter -49.6C Temp. ████████████████████ test</p> </div>

Display Settings

This function allows setting a Tag Name for the current scanner.

<p>At the Main Menu, navigate down using the - key to select Display Settings, and Press E to proceed.</p>	<div data-bbox="943 1686 1458 1890"> <p>Main Menu Extended Calibr. Output Settings →Display Settings</p> </div>
---	---

<p>Set the Tag name for the current scanner. Switch between the digits using the ← key and modify the selected digit using the + keys. Press ↵ to store the option. The display will switch to the Measured Params menu.</p>	<div style="border: 1px solid gray; border-radius: 10px; padding: 10px;"> <p>Tag Name 60</p> <p>test</p> </div>
---	---

Device Info

This function allows setting a Tag Name for the current scanner.

<p>At the Main Menu, navigate down using the ↓ key to select Display Settings, and Press ↵ to proceed.</p>	<div style="border: 1px solid gray; border-radius: 10px; padding: 10px;"> <p>Main Menu Output Settings Display Settings →Device Info</p> </div>
<p>① The screen displays the scanner Serial Number. This is a read-only identifier which is unique to each scanner. Press ↵ to proceed.</p>	<div style="border: 1px solid gray; border-radius: 10px; padding: 10px;"> <p>Serial Number 70</p> <p>709001234</p> </div>
<p>② The screen displays the Software Version of the scanner. Press ↵ to proceed.</p>	<div style="border: 1px solid gray; border-radius: 10px; padding: 10px;"> <p>Software Version 71</p> <p>02.09.988</p> </div>
<p>③ The screen displays the Firmware Version of the scanner. Press ↵ to proceed.</p>	<div style="border: 1px solid gray; border-radius: 10px; padding: 10px;"> <p>Firmware Version 72</p> <p>020</p> </div>
<p>④ The screen displays the Hardware communications interface information for the scanner. Press ↵ to proceed.</p>	<div style="border: 1px solid gray; border-radius: 10px; padding: 10px;"> <p>HW Interface 73</p> <p>4. 20mA/HART Modbus RS485</p> </div>

<p>⑤ The screen displays the Device Type: S, M or MV. Press E to exit and switch back to the Main Menu.</p>	<pre>Device Type 74 3DLevelScanner <MV></pre>
--	---

Device Reset

This function allows selection of different reset options: Reset, Reset to Factory settings and Reset to Lab settings. Use with caution!

<p>At the Main Menu, navigate down using the ↓ key to select Device Reset, and Press E to proceed.</p>	<pre>Main Menu Display Settings Device Info →Device Reset</pre>
<p>① The Reset menu allows selection of the required Reset option. The Reset option brings the scanner to power-up mode and clears measurements. The Reset to Factory option will reset all parameters to their default values as well as performing the Reset option. The Reset to Lab option is password protected and reserved for factory use. Select the desired Reset option using the ↓ key and press E to proceed.</p>	<pre>Reset 80 →Reset Reset to Factory Reset to Lab</pre>
<p>② On selecting Reset or Reset to Factory, a confirmation request screen appears. Select Yes? to proceed with the reset process, or No? to cancel reset. Press E to proceed. A Yes? selection will cause the scanner to reset and restart. A No? selection will cause the display to switch back to the Main Menu.</p>	<pre>Reset the device? 81 →Yes? No?</pre>

Appendix B: Maintenance

Preventive maintenance procedure

BinMaster recommends the following periodical maintenance procedure for keeping the scanner in proper operating conditions and preventing unnecessary malfunctioning which may be caused by environmental factors over time:

Specific conditions of Use

- Part of the enclosure is constructed of plastic. To prevent the risk of electrostatic sparking the plastic surface should be cleaned with a damp cloth prior to any service.
- Clean the interior part of the antennas (see details below)
- Visually check and ensure the communication and power cables are in good condition and are not damaged
- Check and ensure proper sealing of cable entry openings
- Open the rear side of the scanner head and ensure absence of wetness
- The electronics head must be installed in dust Ex areas where intensive static charging will be avoided.
- The device head housing and antenna housing must be installed in gas Ex areas where intensive static charging will be avoided.
- Other than for installation or routine maintenance, the front electronics cover must NOT be opened in gas or dust Ex areas. Electrostatic discharges must be avoided.
- The conditions listed in the respective valid certificates must be strictly observed.
- Manufacturer's technical information related to use of the 3D Level Scanner in contact with aggressive/corrosive media and to avoid any risk of mechanical impact shall be observed.
- The installation of the device or of the Antenna Unit of models providing head separation in the wall to areas requiring EPL Da equipment shall provide a degree of protection IP66 or IP67 and shall be carried out in such a way, that all metallic parts are integrated in the local equipotential bonding.
- Equipotential bonding must be ensured along the intrinsically safe circuit.

Preventive maintenance frequency

The frequency of the maintenance procedure is subject to the conditions and the type of material stored in the vessel. In the case of materials such as salt, sugar, calcium carbonate or similar materials, treatments should be more frequent.

Appendix C: Recommended Tools

The following tools are recommended for the installation process:

- The site application documents (IPF, AAF), and vessel technical drawings
- A set of small precision screwdrivers, to be used with the terminal blocks
- 13mm open wrench
- 4mm hex key (preferably with a handle)
- Large 18 " adjustable wrench
- Stanley knife, cutter, pointed pliers, isolating tape
- Laser measurement device (or other means to ensure correct positioning and distance to the material)
- RS-485 to USB converter, including drivers
- 120Ohm and 250Ohm resistors
- PC/Laptop
- Internet GSM Stick (for testing communications between the installed scanner and the monitoring computer at the center, using the 3DLinkPro).

Appendix D: Specifications

Technical data

Housing & Antenna	Painted aluminum die casting
Inspection window in housing cover	Polycarbonate
Ground terminal	Stainless steel 1.4571/1.4435

Physical

Weight	5.6kg (12.34 lb.)
--------	-------------------

Output variables

Output signal	4-20mA
Resolution	10 μ A
Current limitation	22mA
Communication	RS-485 / Modbus RTU

Plugs and Cabling

- 1 x cable entry M20x1.5 (cable- \varnothing 8...13mm with conductor size of 20 to 24AWG, preferable shielded twisted pairs type cable) assembled on the scanner
- 1 x blind stopper M20x1.5 assembled on the scanner
- Accessory kit with additional M20x1.5 cable gland and 2 x NPT1/2" adaptors

Display panel

Display	LCD 4 lines x 20 characters
Adjustment elements	4 keys (ESC, +, -, E)

Load

4-wire sensor	See load diagram bellow
Integration time	0...9999 s, adjustable

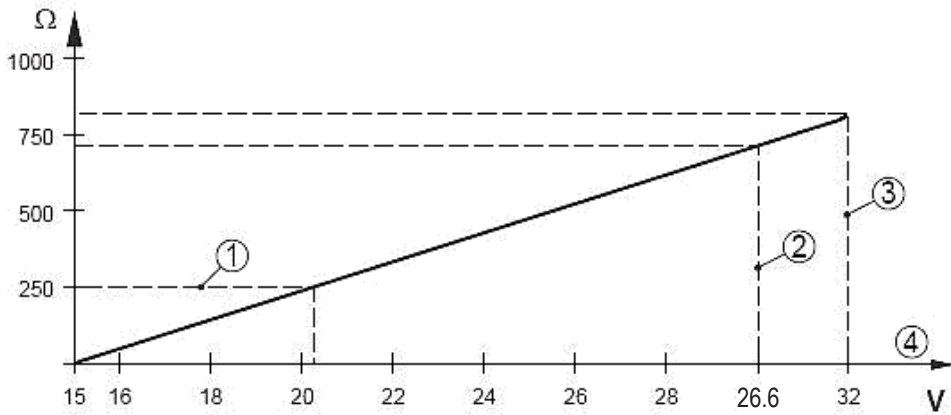

Load Diagram

- 1: HART Load
- 2: Voltage Limit EEx ia device
- 3: Voltage limit non-Ex/Exd ia device
- 4: Supply Voltage

Ambient conditions

Ambient/storage/transport temperature: -40...85°C (-40...+185°F) [3DLevelScanner II]
 -40...120°C (-40...+248°F) [3DLevelScanner II HT]
Note: HT version not FM / IECEx / ATEX approved

Relative humidity 20...85%

Maximum altitude 5,000m (16,400ft)

Process conditions

Vessel pressure -0.5...3bar (-50...300 kPa or -7.25...43.5 Psi)

Process temperature

Measured on the process fitting: -40...85°C (-40...+185°F) [3DLevelScanner II]
 -40...120°C (-40...+248°F) [3DLevelScanner II HT]
Note: HT version not FM / IECEx / ATEX approved

Vibration resistance: Mechanical vibrations of 2g at 5...200 Hz

Measurement characteristics

Frequency 2.65-7 kHz

Beam angle with horn antenna 70 degrees

Interval >2 s (depending on parameter adjustment)

Adjustment time >3 s (depending on parameter adjustment)

Power supply – 4-wire device

Appendix D: Specifications • Technical data

A safety certified power supply which provides double insulation between the primary and output must be used for powering the unit. The power supply must be a limited power source type with maximum output current 1A and voltage range of 20VDC to 26.6VDC, and not to be connected to a DC distribution network.

Power Supply

The power supply will not connect to a DC distribution network.

Supply voltage 20...26.6 VDC

Power consumption max 1.5W

Electrical protective measures

ATEX/IECEX

II 2G Ex ib IIB T4 Gb

II 1/2D Ex ia IIIC T₂₀₀ 110°C Da/Ex ib IIIC T110°C Db

Certificates

BVS 09 ATEX E123 X

IECEX BVS 22.0015 X

Ui-DC 26.6V; Pi=3W; -40°C ≤Ta ≤+85° F

Temperature Class: T4@Ta=-40...85° (-40...185°F)

Process Pressure: -0.5 to 3 BAR PROTECTION

IP54 for Head

IP66 for Antenna

Electronic: 4...20mA/HART-4W/RS485/Modbus

SEE PARAMETERS IN THE CERTIFICATE.

Harmonized Standards

IEC 60079-0:2017, Edition 7.0

IEC 60079-11:2011, Edition 6.0

IEC 60079-26:2021

EN IEC 60079-0:2018

EN 60079-11:2012

EN 60079-26:2015

FM

FM Intrinsic safety CL I,II, DIV I, GP CDEFG

CSA

CSA Intrinsic safety

CE

EMC (2004/108/EC)

Emission: EN 61326: 1997 (class B)

Susceptibility: IEC/EN 61326:1997 + A1:1998
+ A2:2001 + A3:2003

NSR (73/23/EWG)

EN 61010-1: 2001

FCC

- Conformity to part 15 of the FCC regulations
- FCC 47 CFR part 15:2007, subpart B, class A

The 3DLevelScanner complies with Part 15 of the FCC Rules. Operation is subject to the following two conditions: (1) this device may not cause harmful interference, and (2) this device must accept any interference received, including interference that may cause undesired operation.

Dimensions

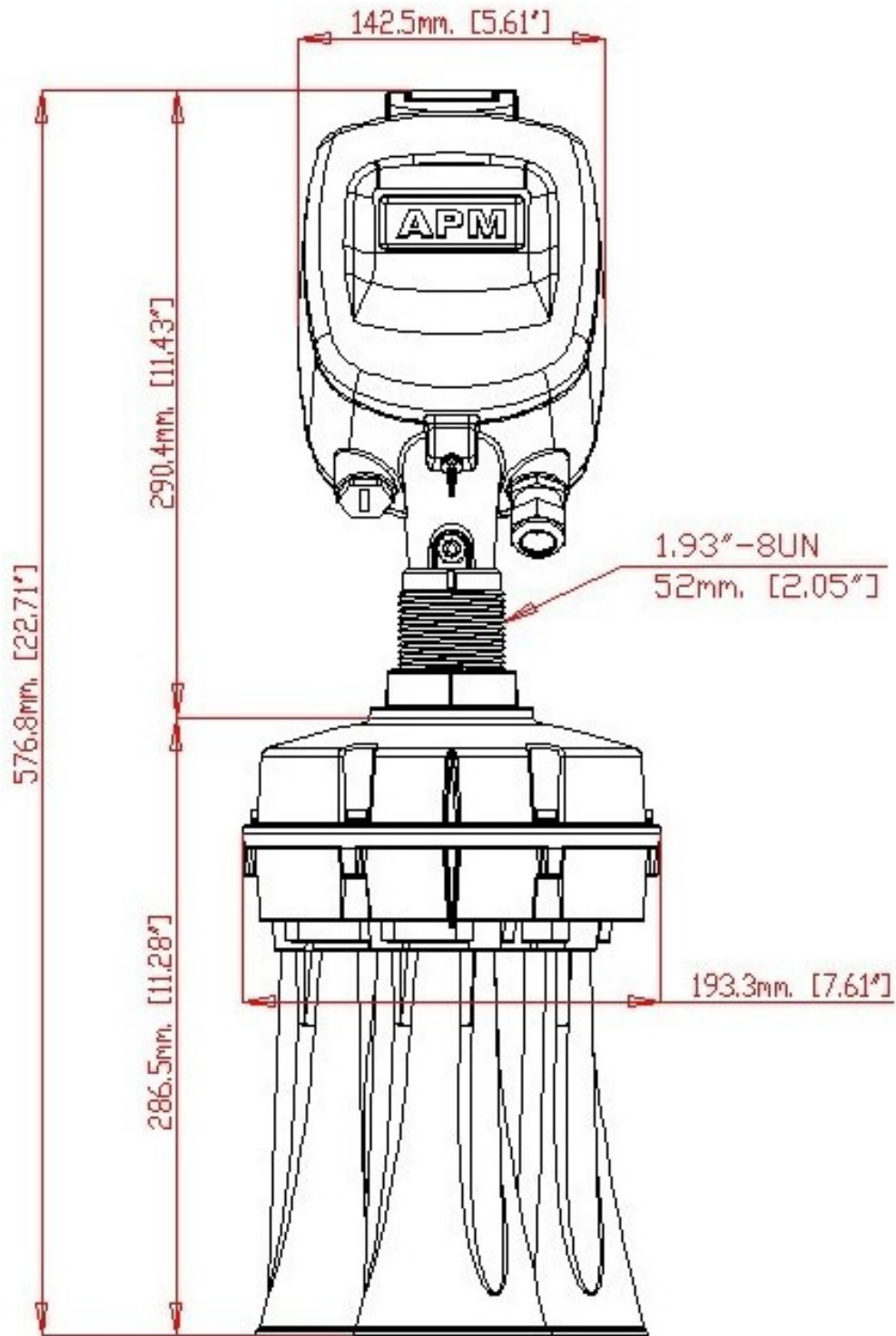

3DLevelScanner dimensions: Front view

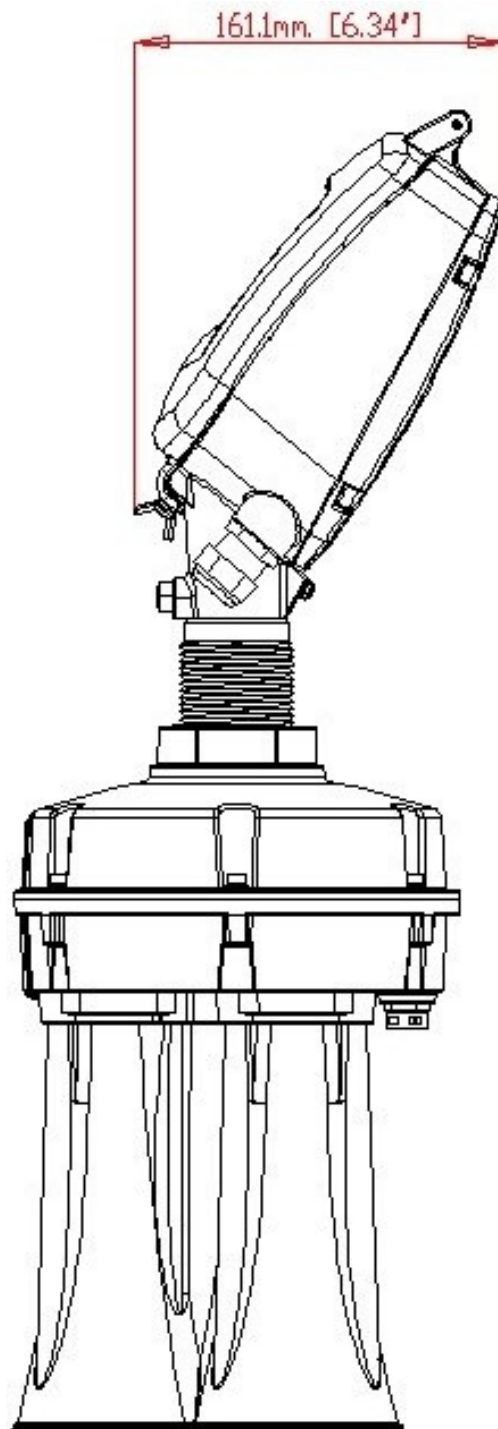



3DLevelScanner dimensions: Side view

Appendix E: Standards & Approvals

3DLevelScanner EMC Test Certificate for FCC Part 15, Sub-part B, Class A

Approved to ISO/IEC 17025

EMC Test Certificate

Certificate No	Page	Date of Issue
K104551.01	1	07 April 2011

Applicant **APM Automation Solutions Ltd.**
Atidim Hi-Tech Industrial Park, Building 2, P.O.B 58171,
Tel Aviv 61580, Israel

 Israel Testing Laboratories

Tested to FCC Part 15, Sub-part B, Class A

Certified Product
E.U.T. 3D LevelScanner II
Model: S*, M**, MV**, MVL**
Serial No.: 25100172
* This model was actually tested.
** See customer's declaration dated 07 April 2011 in ITL test report no. E104551.00.

This is to certify that the product specified herein has been tested and the test results were found to be compliant with the requirements noted above.

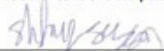
Signature:  Y. Mordukhovitch
EMC Test Engineer

Signature:  I. Raz
EMC Laboratory Manager

ITL091 Rev 1.7 26/06/07

I.T.L (PRODUCT TESTING) Ltd.
PRODUCT SAFETY, EMC & TELECOMS LAB.
Bat-Sheva St., POB 87 LOD 71100 ISRAEL Tel. 972-8-9153100 Fax. 972-8-9153101
Email: standard@itl.co.il, Web Site: <http://www.itl.co.il>

3DLevelScanner EMC Test Certificate for:

- EN 61326-1: 2006
- CISPR 11: 2003 Class A
- IEC 61000-4-2: 2001 Air Discharge, 8kV
- IEC 61000-4-3: 2002 80-1000MHz, 1V/m; 1.4-2GHz, 1V.m; 2.0-2.7GHz, 1V/m
- IEC 61000-4-4: 2004 Power Lines: 1kV; Signal Lines:0.5kV
- IEC 61000-4-6: 2004 0.15-80MHz 1VRMS, 80% A.M. by 1kHz Power & Signal Line

Approved to ISO/IEC 17025

 **EMC Test Certificate**

Certificate No K104550.01 **Page** 1 **Date of Issue** 07 April 2011

Applicant **APM Automation Solutions Ltd.**
Atidim Hi-Tech Industrial Park, Building 2, P.O.B 58171,
Tel Aviv 61580, Israel

 **Israel Testing Laboratories**

Tested to

EN 61326-1: 2006	
CISPR 11: 2003, Class A	
IEC 61000-4-2: 2001	Air Discharge, 8kV Contact Discharge, 4kV
IEC 61000-4-3: 2002	(80-1000 MHz), 1V/m; (1.4-2 GHz), 1V/m (2.0-2.7 GHz) 1V/m 80% A.M. by 1kHz
IEC 61000-4-4: 2004	Power Lines: 1kV Signal Lines 0.5kV
IEC 61000-4-6: 2003	(0.15-80 MHz) 1VRMS, 80% A.M. by 1kHz Power and Signal Lines

Note: The above list of tests was performed according to the customer's request.

Certified Product

E.U.T. 3D LevelScanner II

Model: S*, M**, MV**, MVL**

Serial No.: 25100172

* This model was actually tested.
** See customer's declaration dated 07 April 2011 in ITL test report no. E104550.00.

This is to certify that the product specified herein has been tested and the test results were found to be compliant with the requirements noted above.

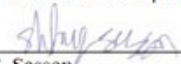
Signature:  S. Sasson
EMC Test Engineer

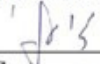
Signature:  I. Rätz
EMC Laboratory Manager

ITL091 Rev 1.7 26/06/07

I.T.L. (PRODUCT TESTING) Ltd.
PRODUCT SAFETY, EMC & TELECOMS LAB.
Bat-Sheva St., POB 87 LOD 71100 ISRAEL Tel. 972-8-9153100 Fax. 972-8-9153101
Email: standard@itl.co.il, Web Site: <http://www.itl.co.il>

Find all your level measurement needs at www.binmaster.com

- ▶ SmartBob weight & cable
- ▶ Rotaries
- ▶ Capacitance probes
- ▶ Vibrating rods
- ▶ Diaphragm switches
- ▶ Tilt switches
- ▶ Ultrasonics
- ▶ Radar
- ▶ Aeration

BINMASTER[®]

800-278-4241 | 402-434-9102

www.binmaster.com | info@binmaster.com

Shipping:

7201 N 98th St
Lincoln, NE 68507

Mailing:

PO Box 29709
Lincoln, NE 68529

V01023 FEB 2023 REV A

©2023 Garner Industries DBA BinMaster Level Controls