

This drawing is the property of Garner Industries. It is issued in confidence on the condition that it is to be returned on request and that it is not to be copied or reproduced in any way, or used in the manufacture of the subject matter thereof without the written consent of Garner Industries.

DIMENSIONS ARE IN INCHES UNLESS NOTED OTHERWISE

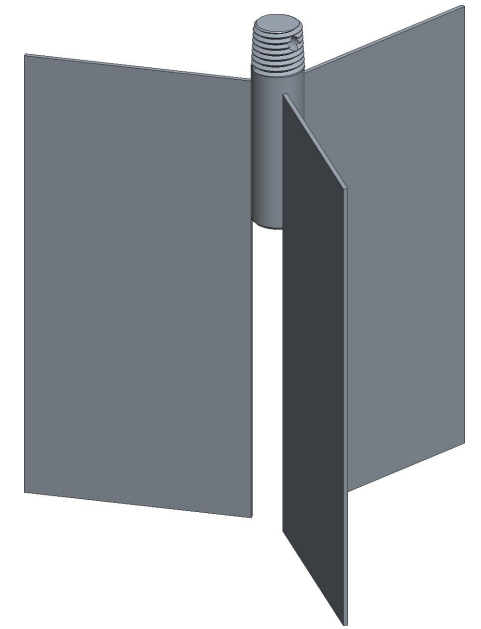

Division of Garner Industries / 7201 North 98th Street / Lincoln, NE 68507  
 (402) 434-9102 / fax (402) 434-9144 \ www.binmaster.com

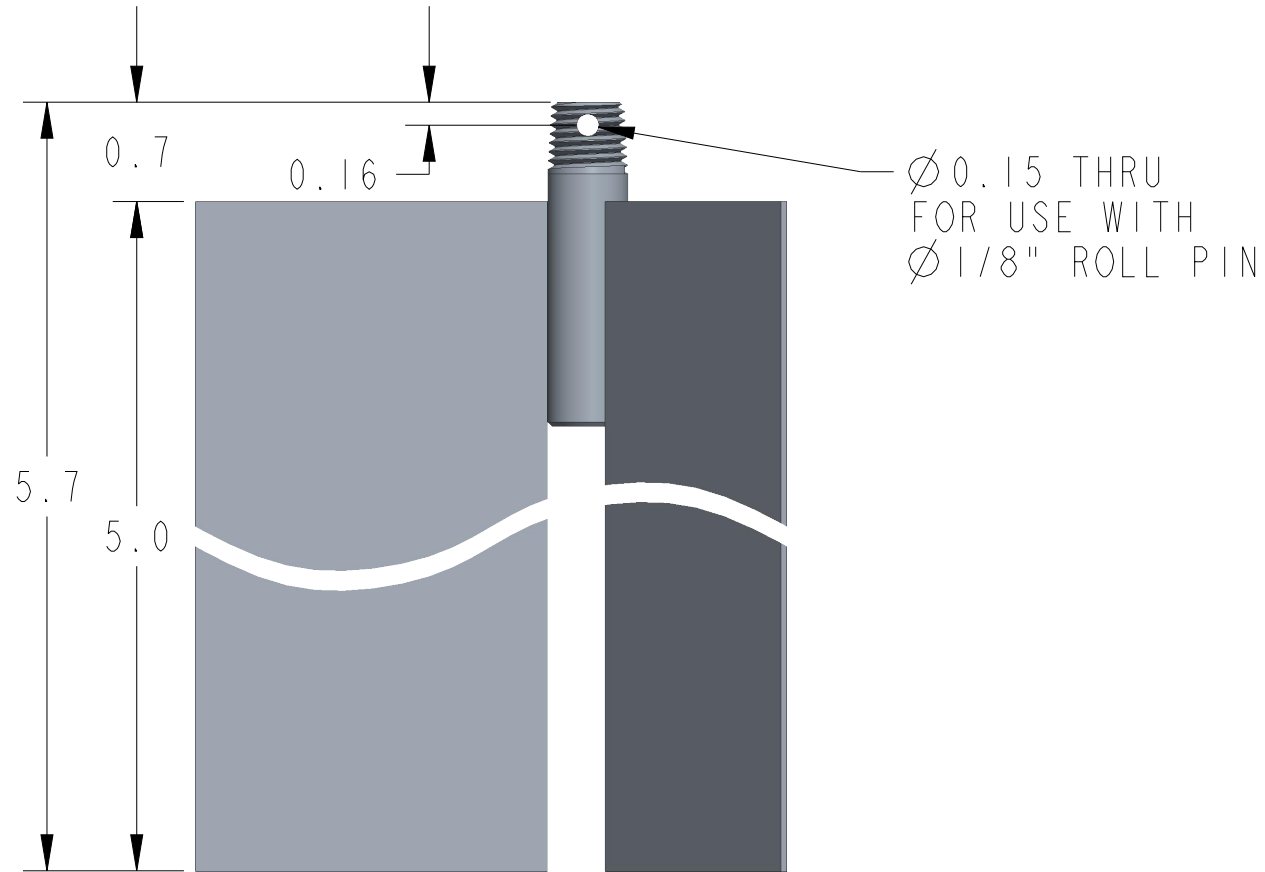

SCALE 0.500

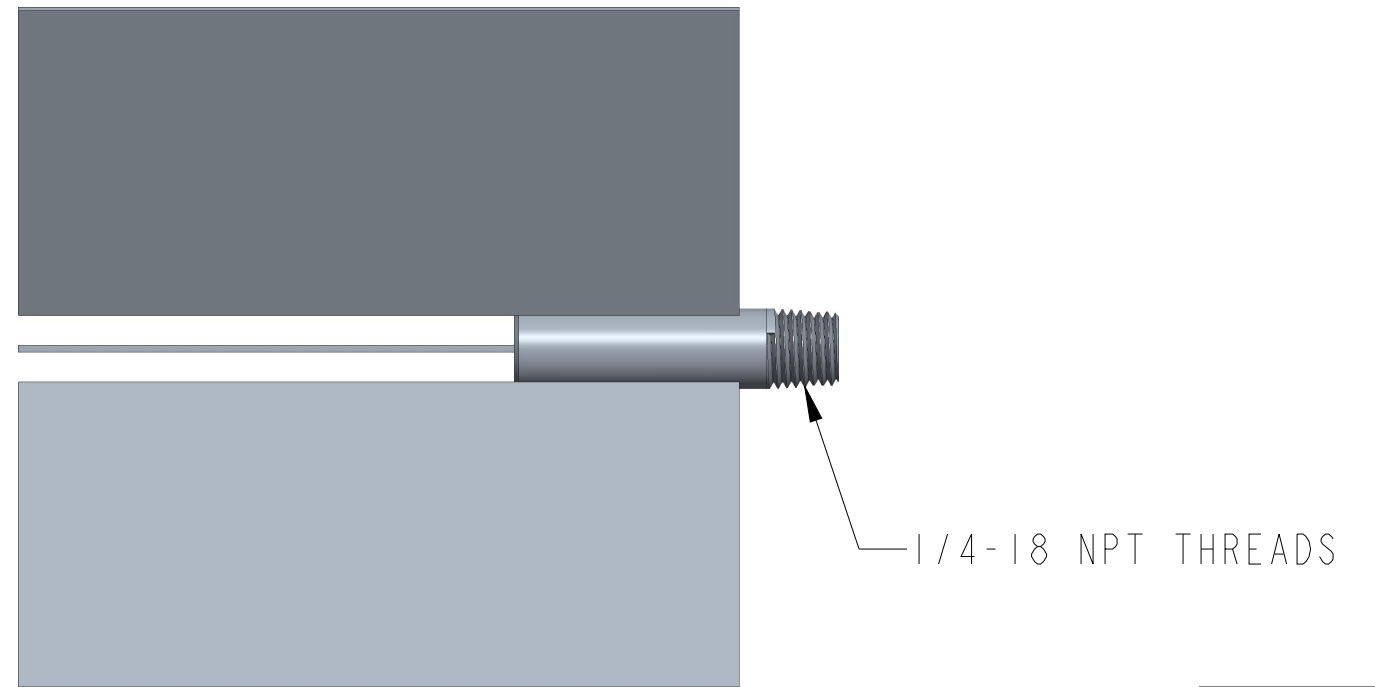
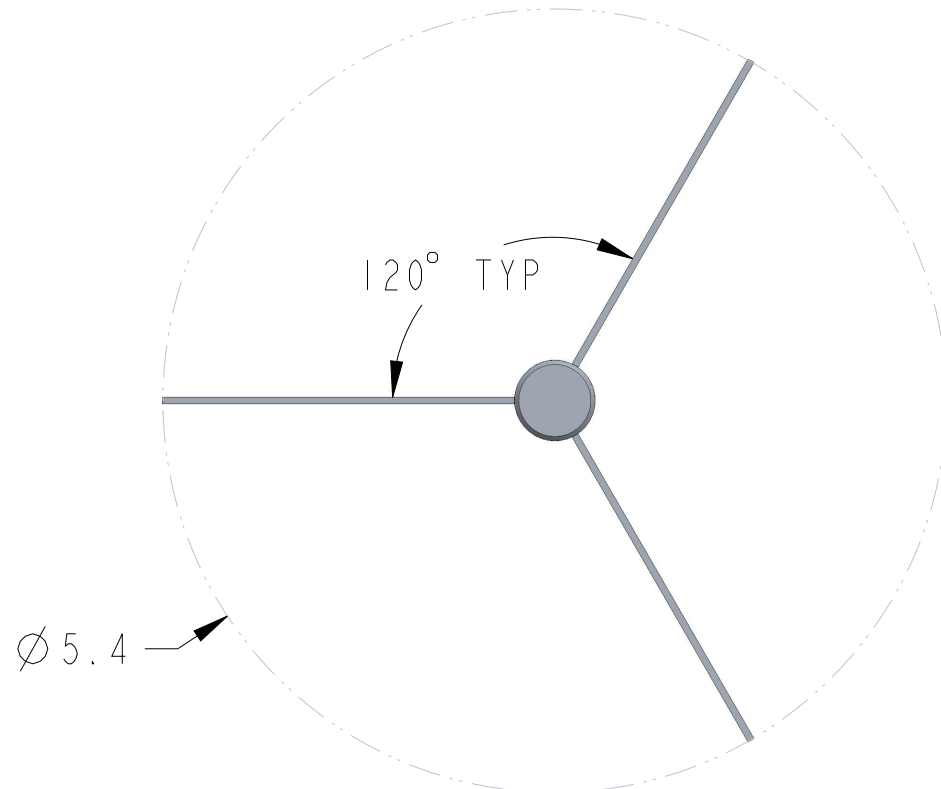

SCALE 0.750

REVISION

TITLE: MTG DIM, PADDLE, GRP-25

Model No.: GRP-25

P/N: 416-0261

DWG No.: 418-0078

MATERIAL: 304 STAINLESS STEEL

PAGE 1 OF 1